

# CAUTION !

1. Ensure this appliance is properly earthed.
2. Do not replace any part other than Neiken brand. This is to ensure optimal performance and safe for use.
3. Do not attempt to repair the fan! Kindly return the fan to our authorized service agent.
4. This fan must be mounted at least 3.0m (10ft) above ground.
5. Disconnect power supply before performing assembly, disassembly or repair.
6. It is recommended to examine the fan at least once every 2 years.

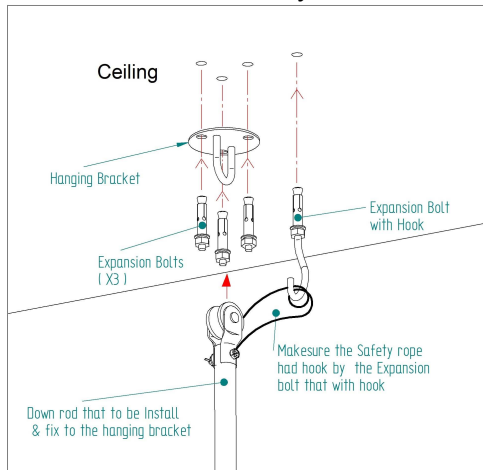
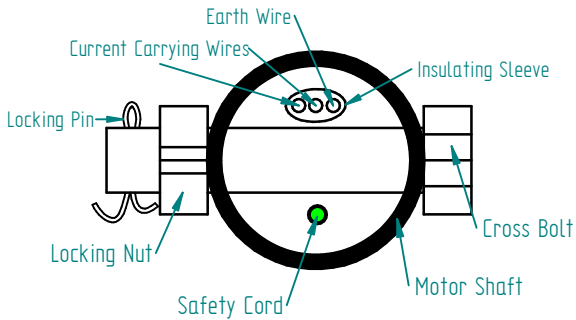

## SPECIFICATION

Voltage	Fan Size	Frequency	Wattage	Air Delivery	C.O.P	Speed (RPM)	
240V AC	60"	50Hz	80W	250 m <sup>3</sup> /min	3.0 m <sup>3</sup> /min/W	L	H
						90	260

\*Specifications will vary and subject to change without prior notice

**Neiken Electric (S) Pte Ltd**  
 No. 9 Tagore Lane #01-16, 9@Tagore ,  
 Singapore 787472

# neiken

## 60" (1500mm) Ceiling Fan

**Model:N 260 AC / N 260 AC S**

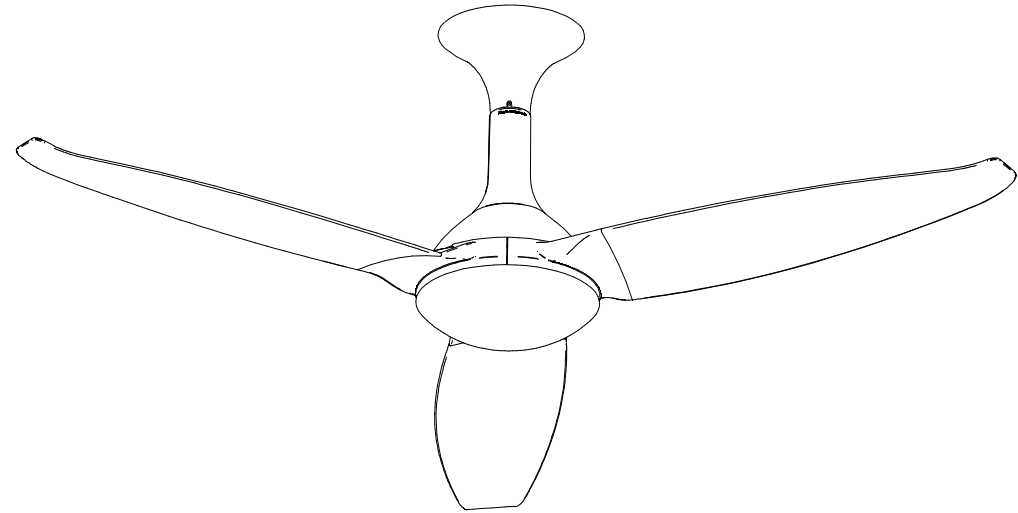

# User Manual

Read this manual completely before operating this appliance.  
 This appliance is not to be handle by any person (including children) with reduced physical, sensory or mental capabilities, or lack of experience and knowledge, unless they are supervised by a professional or have been given instructions.  
 Children are highly advised not to play with this appliance.

# In The Box

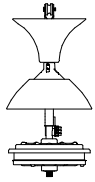

Fan Motor x 1



Fan Blade x 3

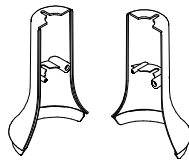

Middle Cover x 2

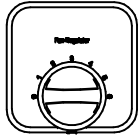

Fan Regulator x 1

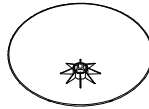

Bottom Cover x 1

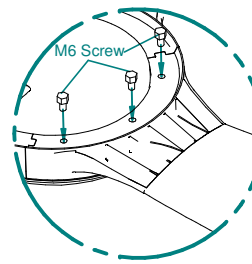

Align fan blade hole to the motor and mount using the M6 screws. Repeat for other fan blades.

\*Use PH2 stubby phillips screwdriver and 10mm spanner.

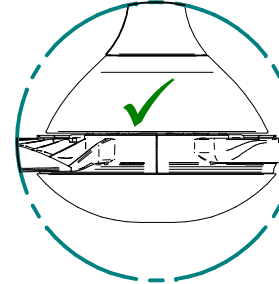

Rotate bottom canopy till wires slotted in correctly with minimal gap clearance as shown.

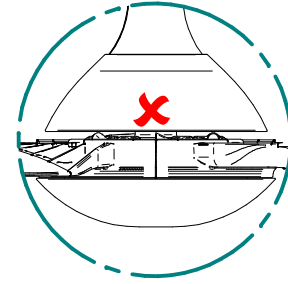

## Wiring Diagram

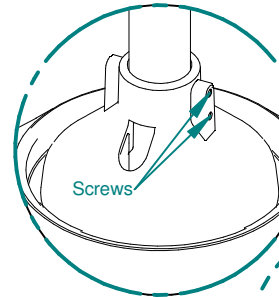
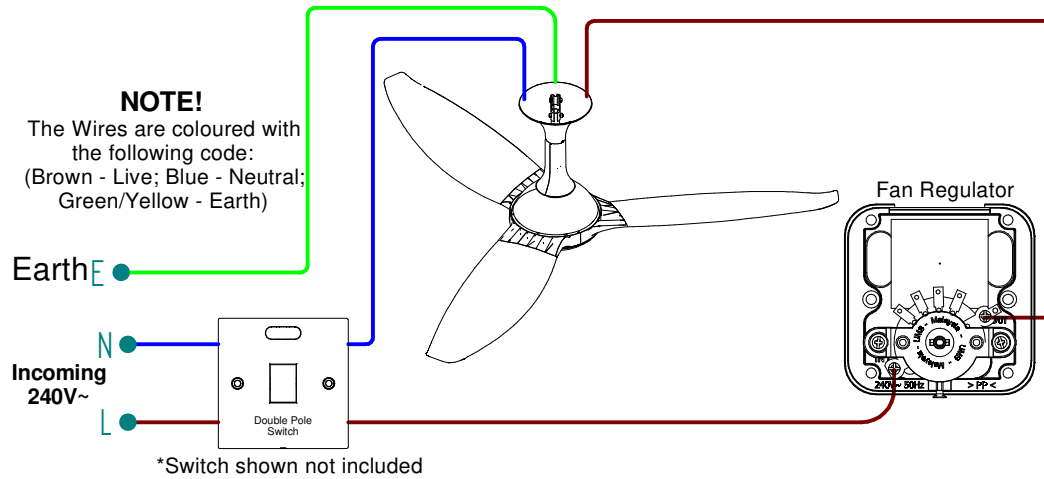

Check gap clearance before tightening bottom canopy using both the screw holes provided. Use only one side.

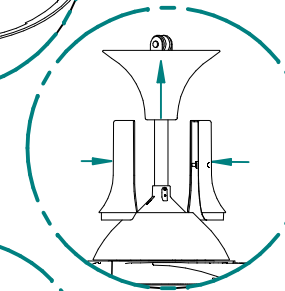

Slide top canopy to the ceiling and tighten using the screw hole provided before assembling and tightening the middle cover.

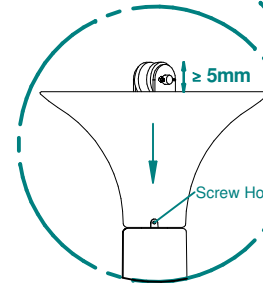

Loosen and lower top canopy to the middle cover and tighten. Minimum 5mm gap or more from ceiling to the top canopy.

## Assembly Instruction

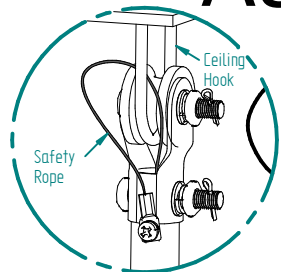

Ensure that the safety rope passes through the fan hook and then securely fastened using the screw provided.

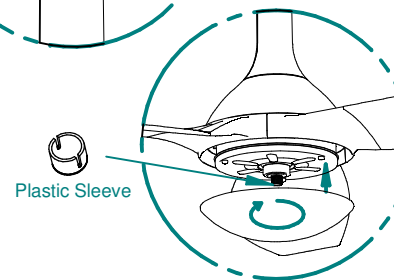

Remove plastic sleeve from the shaft thread before tightening the bottom cover\*.

\*Clockwise direction to fasten